

# ***R12 Bluetooth/2.4G UHF handheld***



UHF handheld is a special card reader and barcode scanner that supports one-dimensional code/two-dimensional code/915Mhz UHF tags based on barcode recognition, RFID radio frequency identification technology and Bluetooth communication. Not only the power consumption is low, the standby time can be as long as 1 year, which changes the traditional data line transmission method, and there is no need to load additional power (the handset comes with a lithium battery). Only the receiving end Bluetooth and the handset Bluetooth pairing are successful Upload the epc number of the UHF tag directly to the receiving end of the device via Bluetooth.

## User notice

- Please read this user manual carefully before using this device.
- The charging voltage of the handheld is 5V, please charge with a suitable power supply.
- The company reserves the right to make changes to any product to improve its reliability, improve its function or design, for the application or use of any product, circuit, or related to or related to other applications described herein. The company is not responsible for any product liability arising therefrom.
- Handheld accessories  
The standard configuration of the handheld: a handheld, a receiver, a USB cable, a manual, a product certificate.
- The contents of this manual are subject to change without notice.

## Specifications

- No password authentication is required for pairing, and it can be paired directly.
- Sensitive scanning code recognition rate is high
- 3500mA/h large-capacity battery ultra-long standby (normal charging 8 hours, standby time up to 1 year)
- The handheld has a long communication distance, and the Bluetooth stable communication distance is up to 10 meters. The wireless 2.4g outdoor communication distance is up to 150 meters.
- Equipped with a mobile phone holder, which can combine the mobile phone with the handheld, which is more convenient to use
- Fast transmission speed, no need to load program.
- It can be charged directly with the mobile phone charger plug.

- The data output defaults to the carriage return function, without manual selection.
- It is widely used in Windows, IOS, Android and other devices with Bluetooth communication

## Product parameter

Model	R12
Working frequency	915Mhz
Card reader type	ISO 18000-6C
Barcode type	One-dimensional code, two-dimensional code, screen code
Communication method	USB/Bluetooth/2.4G wireless
Reading distance	0m-3m (the specific effective reading distance is related to the tag type)
Card reading rate	106K/Bit
Card reading speed	0.1S
Reading distance	0.5S
Card reading time	< 100mS
Operating temperature	-20℃—70℃
Working current	100mA
Charging voltage	5V
Battery capacity	3500MA/H
Size	171mm×191mm×88mm (product); 225mm×205mm×95mm (including packaging)
Weight	400G (net weight)/600G (including packaging)
operating system	Operating systems such as IOS\WINXP\Win 7\Win 10\ Android\LINUX
Other	Status indicator: 4-color LED "Red" charging indicator light; "green" reading indicator light "Orange Red" working indicator light; "Blue" connection indicator light Built-in buzzer sound

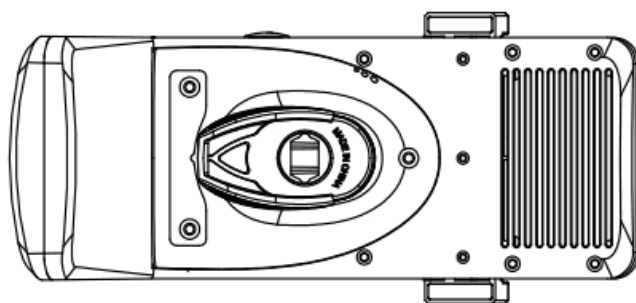
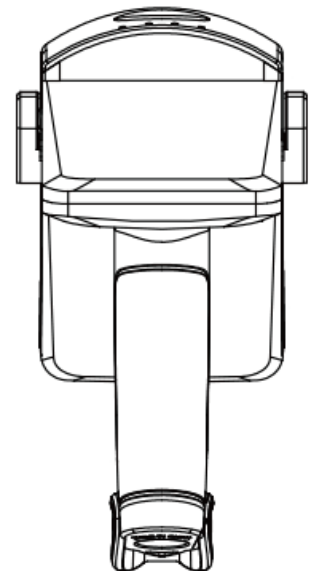
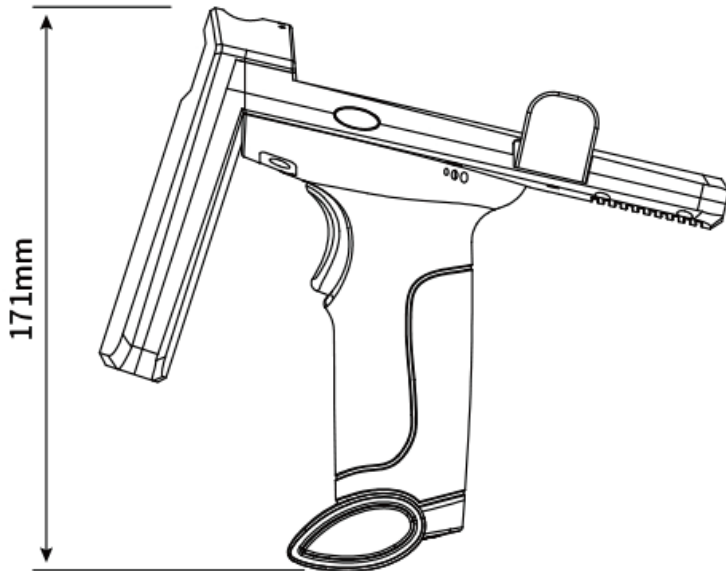
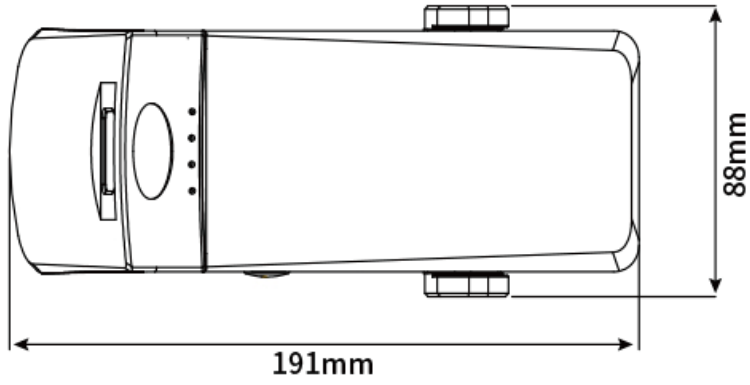

## Connection method

This product has three connection methods, USB cable direct connection, wireless 2.4g and Bluetooth

The USB wired connection method is as follows:

1. Short press the handset trigger button to turn on
2. Connect the handheld and the device with the supporting USB cable.
3. Open the corresponding software on the device to scan and enter.

The wireless 2.4g connection method is as follows:

1. Short press the handset trigger button to turn on
2. Connect the wireless receiver to the USB port of the device.
3. Open the corresponding software on the device to scan and enter.

The Bluetooth connection method is as follows:

1. Short press the handset trigger button to turn on
2. Turn on the Bluetooth function of the mobile phone or other device and search for Bluetooth devices.
3. Find the device named "FSC-BT957" and click Connect.
4. With a beep when the pairing is successful, the blue indicator light is always on.

## Indicator light description

1. "Red" charging indicator light: always on when charging
2. "Green" reading indicator: flashes once after successful card reading/scanning
3. "Orange red" work indicator: always on after power on
4. "Blue" connection indicator light: flashes when connected, and always on after a successful connection

## Operation instructions for card reading function

Press the side function key, when the buzzer sounds once, it will enter the card reading mode, support the label of ISO18000-6C protocol, and the recognition distance can be up to 3m (the distance may vary according to the type of label)

After connecting the device, open the software (such as a form or text file) that needs to record the card number, and place the cursor at the position that needs to be entered to operate the card reading. The format and function operations are as follows:

### 1、Connecting devices and software

Connect the card reader with the computer, double-click to open the ap

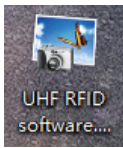
plication program  , and click the read button. The current format of the card reader will be displayed in the status box on the right side of the software.

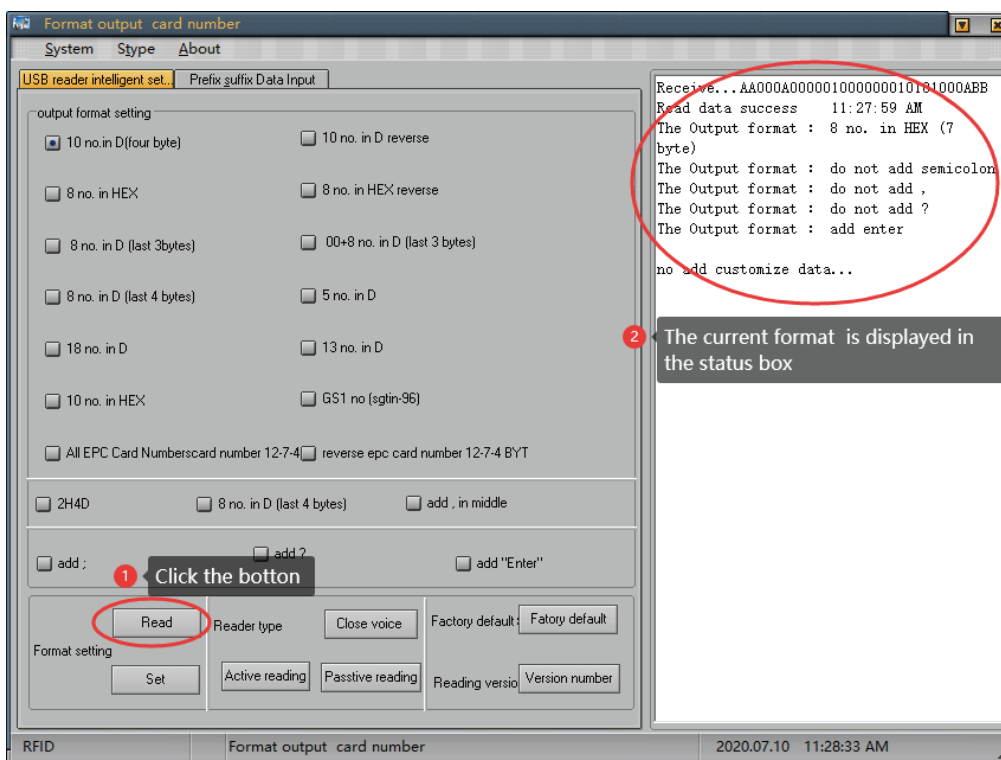

If the connection fails, see the figure below

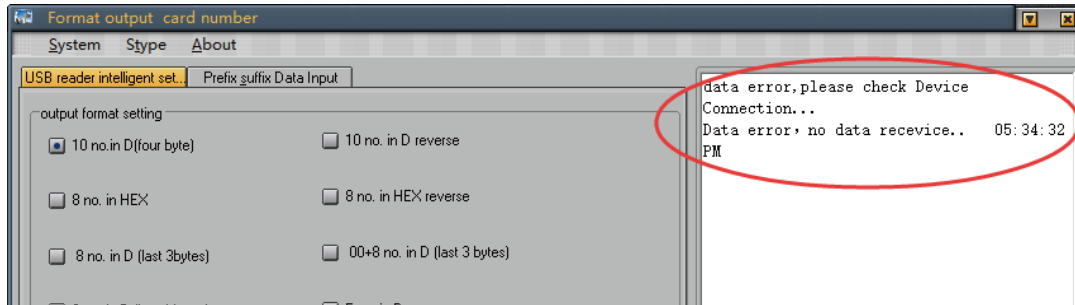

## 2、Reader status output format

### 2.1 Output format setting

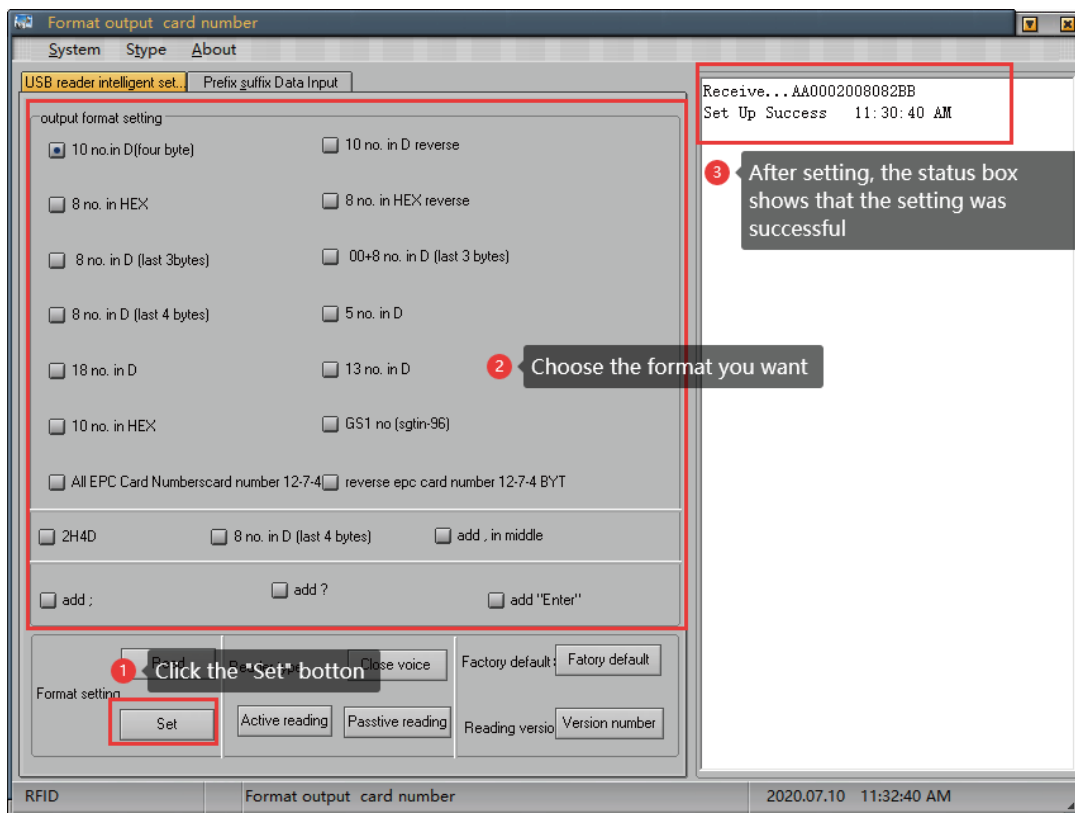

## 2.2 Reader type settings

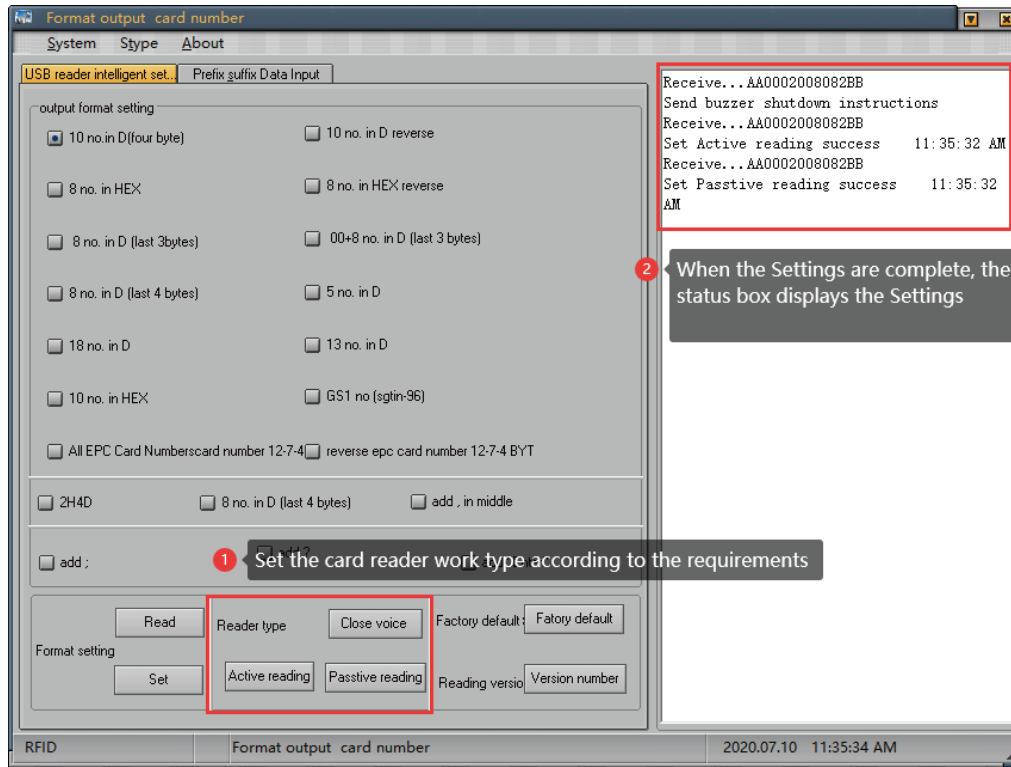

## 2.3 Restore factory settings and version number query

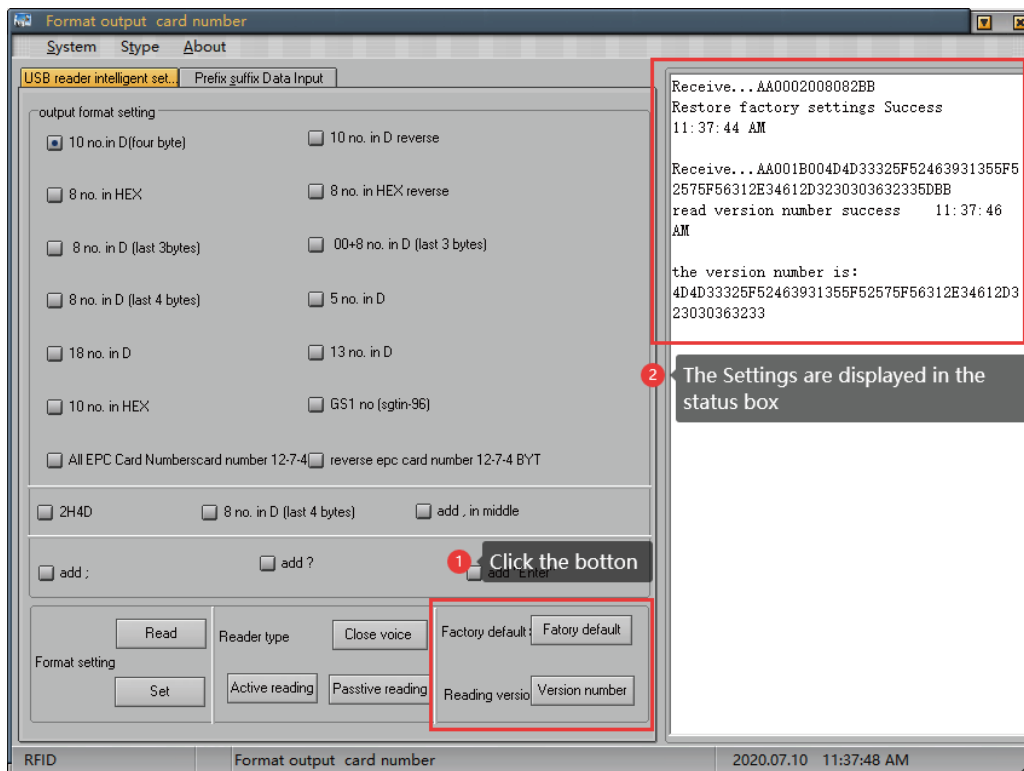



### 3、 Prefix and suffix data entry

#### 3.1 Prefix and suffix settings

Fill in the prefix and suffix that need to be added here, up to four bytes. After completing, click the setting button behind, the status window on the right side will display the successful setting, as shown in the figure:

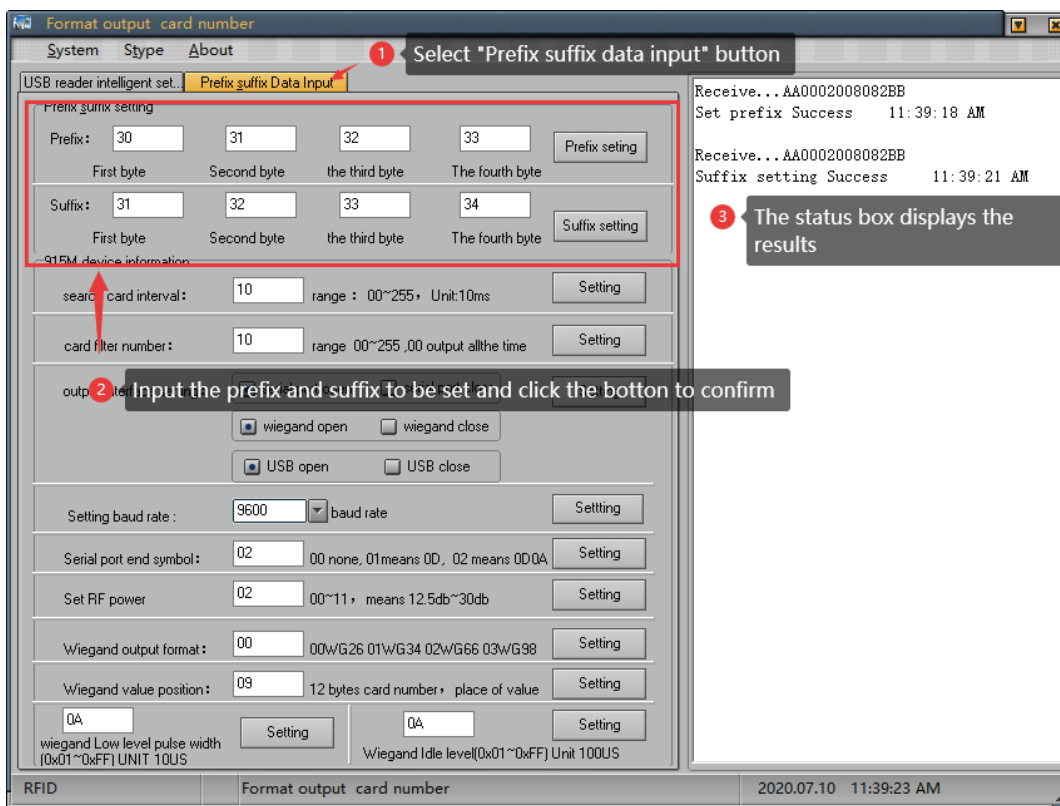

#### 3.2 915M machine information

Card search interval value refers to the time interval between two card readings. The larger the value, the longer the interval time;  
 Card filtering times refer to the number of repeated card readings. The larger the value, the longer the interval between repeated readings;  
 Output interface setting, open or close the corresponding interface according to requirements, click the setting button to complete the setting;

The default baud rate is 9600, select the required value and click the right setting button to complete the setting;  
 Add a serial port input terminator, enter the character to be set in the input window, and click the set button to complete the setting;  
 RF power setting, the greater the value, the higher the power, the farther the sensing distance, enter the required value, click the setting button to complete the setting;  
 Wiegand output format, enter the corresponding value, representing the corresponding format, click the setting button to complete the setting;  
 Wiegand value location, 12-byte card number, fill in the required location, click the set button to complete the setting;  
 Wiegand low-level pulse width range and Wiegand idle-level pulse width range, fill in the value to be set (0x01~0xFF), click the setting button to complete the setting, as shown below:

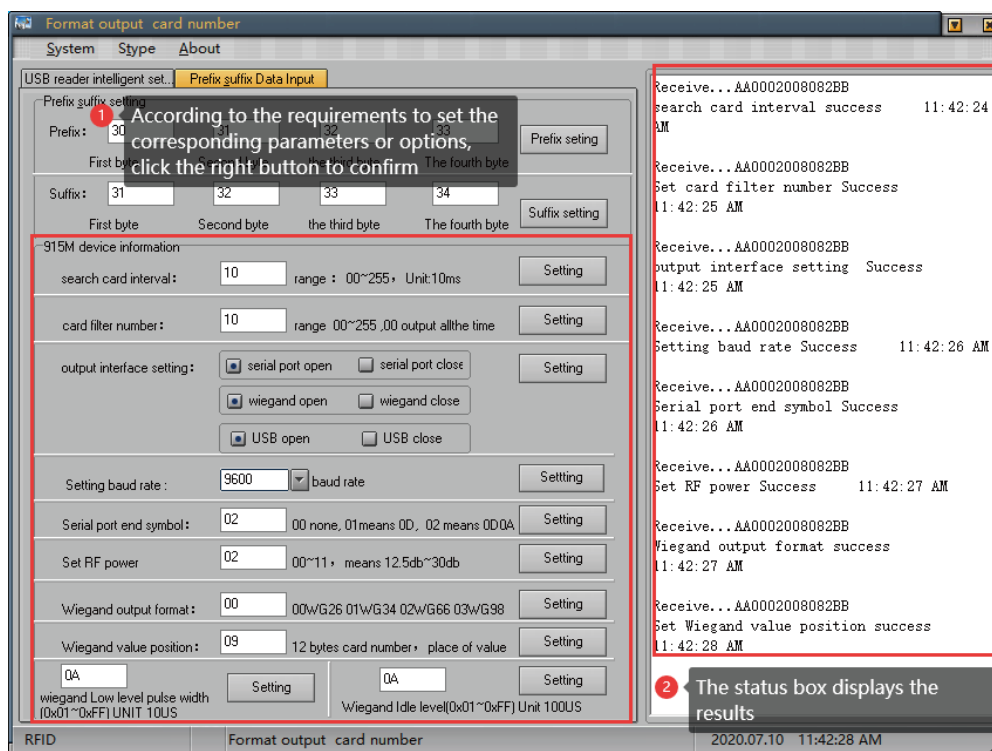

## Scan code function operation instructions

Press the side function key, when the buzzer beeps twice, it will enter the scan code mode, aim at the barcode scan to upload the barcode data to the device. Scan the corresponding setting code below to adjust the function of the handheld. Some scan feedback information needs to be displayed on the document.

### Basic system settings

1. Restore the initial state by scanning the "Restore Factory Settings" barcode

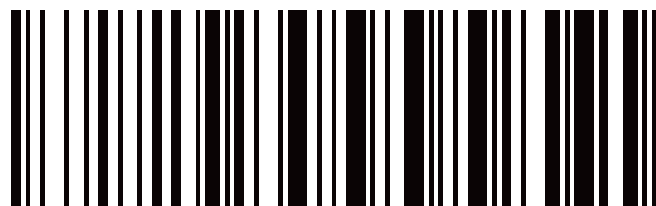

(%%Restore)

2. Turn off the device by scanning the "shutdown command" barcode

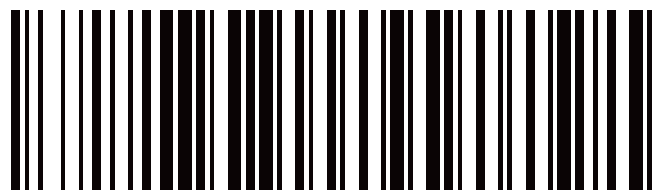

(%%Power Off)

3. There is no response when the wireless receiver is plugged in. It is paired by scanning the "One Piece Pairing" barcode. Scan first, and then plug the receiver into the computer to complete the pairing after hearing a continuous beep.

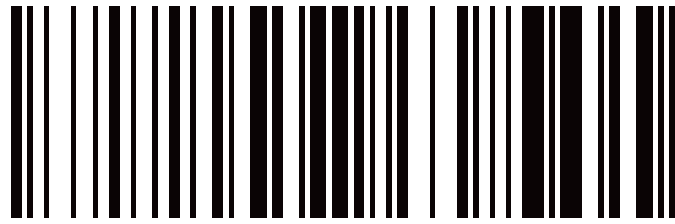

(%%EZPair)

4. Check the remaining battery power of the device by scanning the "Display battery power" barcode, and the scanning result will appear in the cursor input area

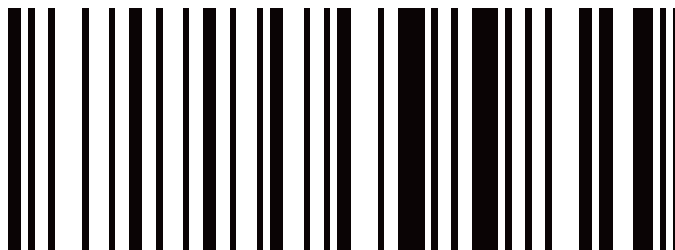

(%%Batt)

5. Scan the "software version information" barcode to view the device version number, the scan result will appear in the cursor input area

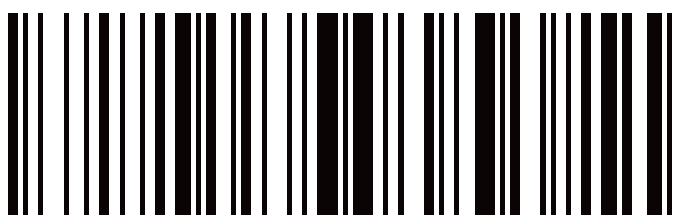

(%%Version)

### End character setting

1. Add a carriage return to the output suffix by scanning the "Add carriage return" barcode



(End CR)

2. Add the TAB character to the output suffix by scanning the "Add TAB" barcode



(%%EndTab)

3. Add a carriage return and a newline character to the output suffix by scanning the "Add carriage return + line feed" barcode



(%%EndCRLF)

4. Set the output result without suffix by scanning the bar code "End-None"



(%%EndNone)

## Buzzer settings

1. Turn on the buzzer of the device by scanning the barcode of "Enable Scanning Prompt Tone"

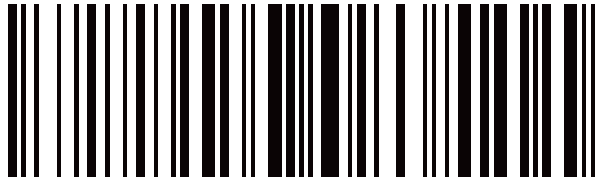

(%%BZOpen1)

2. Turn off the buzzer of the device by scanning the barcode of "Turn off the scanning prompt tone"

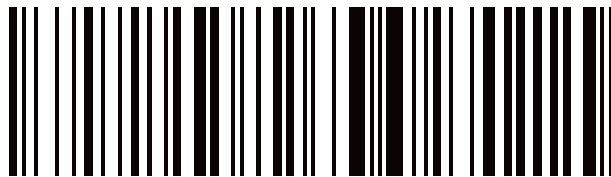

(%%BZClose1)

## Sleep time setting

Scan the "sleep time SET" barcode to enter the setting mode, and then scan the sleep time you want to set

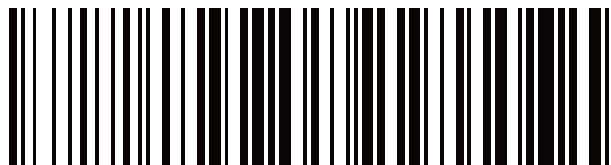

sleep time SET(%%ALLTIMSET)

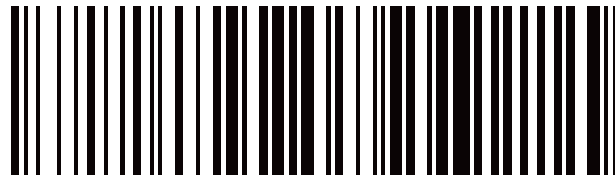

30 Sec(%%ALLTIM01)

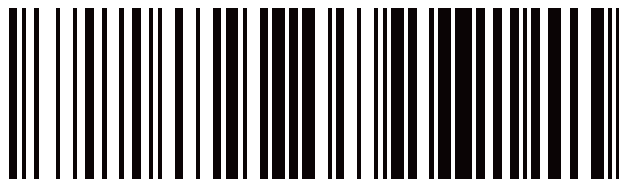

60 Sec (%%ALLTIM02)

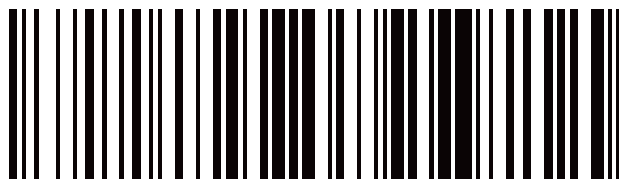

5 Min (%%ALLTIM04)

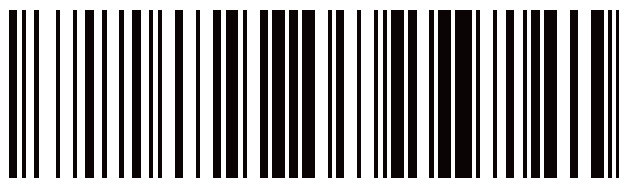

10 Min (%%ALLTIM05)

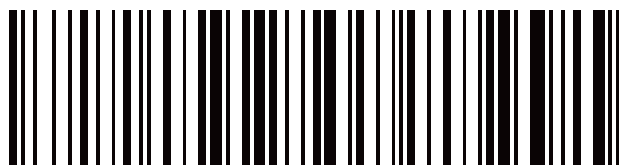

No sleep (%%ALL\*TIDIS)

## Mode setting

The scanner has three operating modes: normal mode, inventory mode and non-loss mode. The operating mode can be switched through different setting codes

- In normal mode, the scanned data is directly transmitted to the computer or mobile phone via wireless or Bluetooth, and the scanner will emit a low-frequency short tone after the transmission is successful. If the transmission fails, 3 short low-frequency tones will be issued to warn. In normal mode, if the transmission fails, the scanned barcode will be lost.

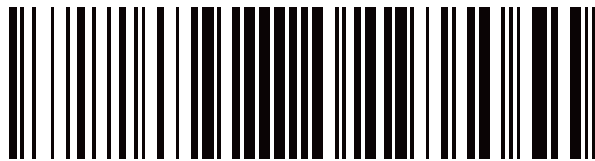

(%%ALLPT-SET)

- If the scanner works beyond the wireless or Bluetooth transmission range, it is recommended to use the inventory mode. In inventory mode, the scanned data is stored in the internal storage of the scanner. When a barcode is scanned, the scanner will emit a short tone, and the scanned barcode will be automatically stored in the scanner. If the internal storage is full, the scanner will emit 3 low-frequency short tones as a warning, read the scanner's The setting code will be introduced later.

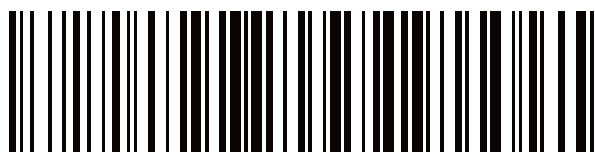

(%%ALLMEM-SET)



- In the non-lost mode, the barcode scanned by the scanner will be directly transmitted to the computer or mobile phone if it is successful, and will be automatically stored in the scanner's internal storage when it fails to solve the problem of data loss

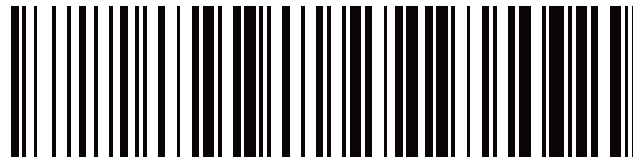

(%%ALLAEM-SET)

## Data management

Scan the "Total Data" barcode to view the number of barcodes stored in the scanner, and the result is displayed in the cursor input area

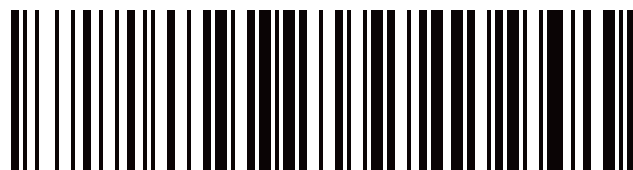

Total Data (%%ALLMEM-ZS)

Upload the stored data by scanning the "Data Upload" barcode. The barcode stored in the scanner will not be deleted automatically after the data is uploaded, and the user can upload the stored data multiple times by scanning "Data Upload".

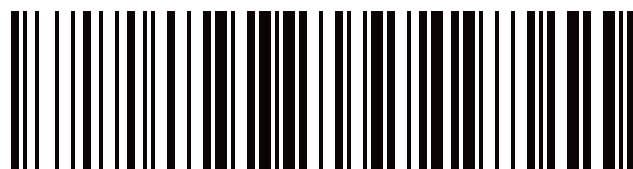

Data Upload (%%ALLMEM-SC)

Scan the "Clear Data" barcode to clear the stored barcode data. After the barcode is cleared, upload can no longer be performed. Please confirm whether the data has been uploaded before clearing.

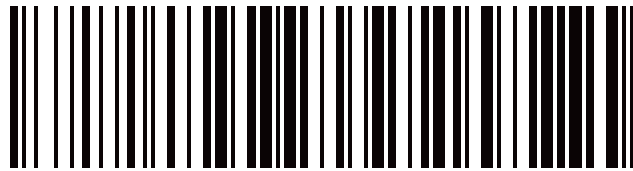

clear data (%%ALLMEM-QC)

## Common problem

Why can't the barcode be uploaded to the computer or mobile phone after pairing?

1. Confirm whether the pairing is successful, the first blue LED indicator on the right side of the pairing is always on
2. Whether the inventory function is enabled (bar codes will not be automatically uploaded in inventory mode, you need to manually scan the corresponding setting code to upload)
3. Change to normal mode and upload while scanning

What should I do if the device fails to connect after the wireless receiver is plugged in?

Unplug the receiver, and then scan the one-key pairing setting code for pairing. After scanning, it will emit a continuous low beep tone. At this time, plug the receiver into the computer. When the tone stops, it indicates that the pairing with the receiver is successful. used

Why there is no response when scanning the setting code?

Scan the setting code that shows the version number to check the version number and make sure it is the software version that matches the current manual

How to change more scan settings?

Please contact the manufacturer

## Precautions

- The card reader only reads radio frequency cards and barcodes, including ISO18000-6C tags, one-dimensional codes and two-dimensional codes, and does not support reading Bluetooth card data (Bluetooth card frequency band is 2.4G);
- When scanning codes or reading card data, please switch the input method of the mobile phone or other platforms to English for more complete data output;
- The way of reading the card, it is recommended to use the card directly facing the card reader and approach it naturally. The card reading method that uses the card to quickly swipe from the side is not advisable and does not guarantee the success of the card.
- The configured data cable does not have communication function and is only used to charge the card reader. The card reader cannot upload data to the operating platform with this data cable.

- The handheld has its own sleep system. When the card reader is not in use, it will automatically sleep after 60s. If you need to restart it, press the button again, and the card reader can enter the working state again.
- If the data cable is directly inserted into the charging plug, the card reading will be unsuccessful.
- If the reading distance of the card reader is too long, it will cause the card reading to be unstable or fail. Avoid reading the card in a critical state (the distance just to be able to read the card). At the same time, two readers that are too close will interfere with each other.
- When swiping the card, it is recommended not to operate the mouse to avoid data transmission errors.
- The length of the communication cable between the card reader and the computer should be less than 15 meters.
- No response when swiping the card:
  1. Check if the interface is plugged in;
  2. 360 antivirus software block, close antivirus software or add whitelist;
  3. The driver cannot be recognized repeatedly, right-click on the calculator, select Device Manager, ergonomic input device, then right-click the mouse, select the driver delete, click the operation in the menu bar, select the scan detection hardware;
  4. Whether the radio frequency card is the corresponding RFID card type;
  5. Whether the radio frequency card is broken;
  6. Whether another radio frequency card is within the reading range.

- Data transfer error: whether the mouse is operated when swiping the card; whether the card is read in an environment with strong electromagnetic field interference; whether the communication cable between the card reader and the computer is too long; whether the card is read in a critical state.
- After reading the card, the buzzer will beep 3 times, and you should check if the connection is successful